

Potain Igo 28A

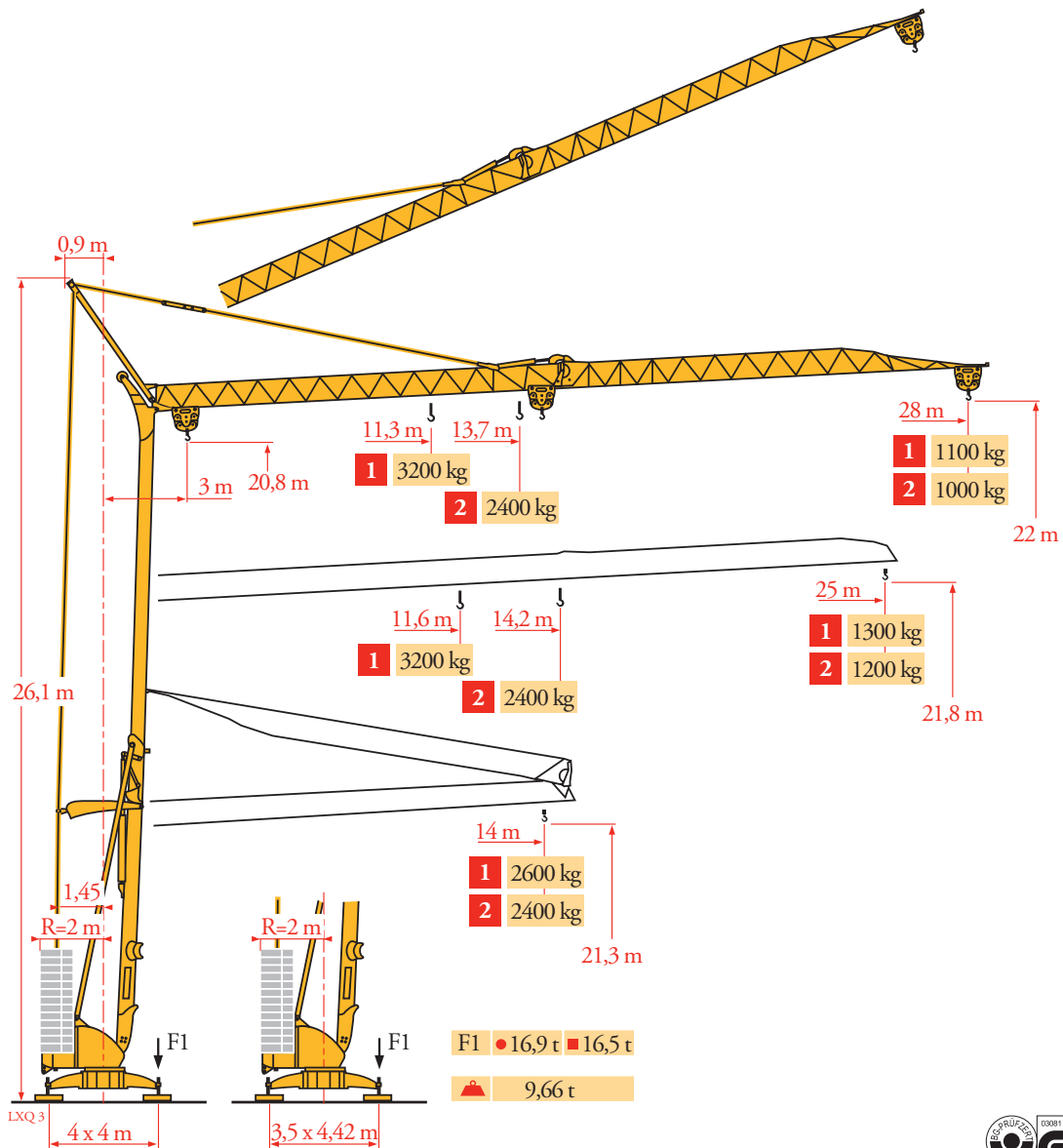

Courbes de charges
Lastkurven
Load diagrams
Curvas de cargas
Curve di carico
Curva de cargas
Диаграммы грузоподъемностей

LXQ 3

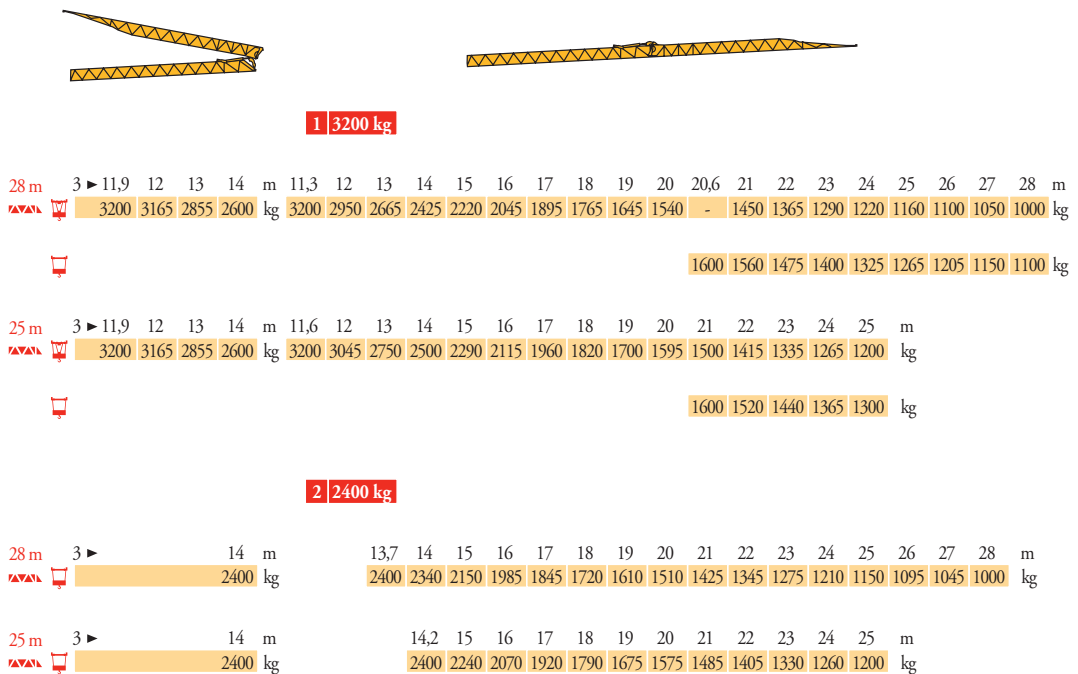

Flèche relevée
Ausleger in Steilstellung
Luffing jib
Flecha izada
Braccio impennato
Lança inclinada
Маховая стрела

LXQ 3

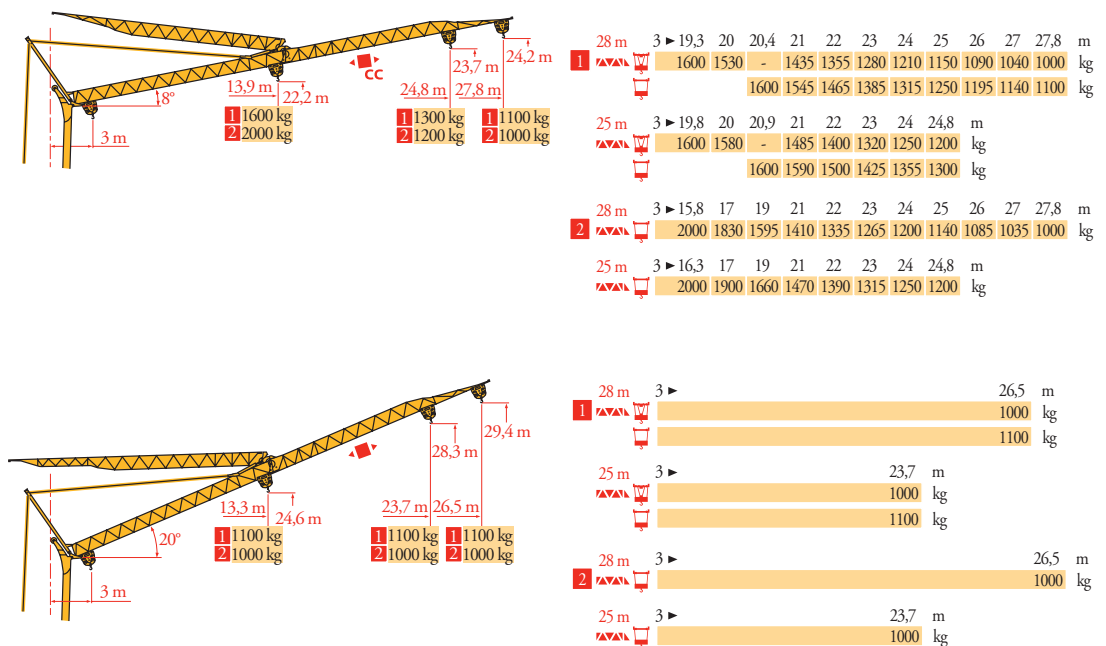

FR

Chariot distributeur
Chariot distributeur et courbes de charges
Réactions en service
Réactions hors service

A vide sans lest (ni train de transport) avec flèche et hauteur maximum

DE

Verfahrbare Laufkatze
Verfahrbare Laufkatze und Lastkurven
Reaktionskräfte in Betrieb
Reaktionskräfte außer Betrieb
Ohne Last, Ballast (und Transportachse), mit Maximalausleger und Maximalhöhe

EN

Traversing trolley
Traversing trolley and load diagrams
Reactions in service
Reactions out of service
Without load, ballast (or transport axes), with maximum jib and maximum height

ES

Carro distribuidor
Carro distribuidor y curvas de cargas
Reacciones en servicio
Reacciones fuera de servicio
Sin carga, sin lastre, (ni tren de transporte), flecha y altura máxima

IT

Carrellino distributore
Carrellino distributore e curve di carico
Reazioni in servizio
Reazioni fuori servizio
A vuoto, senza zavorra (ne assali di trasporto) con braccio massimo e altezza massima

PT

Carro distribuidor
Carro distribuidor e curva de cargas
Reacções em serviço
Reacções fora de serviço

Sem carga (nem trem de transporte) - sem lastro com lança e altura máximas

RU

Грузовая тележка
Грузовая тележка и диаграммы грузоподъемностей
Реакции при работе
Реакции в покое
Вес без груза, балласта (или транспортных осей), с максимальной длиной стрелы и максимальной высотой

Mécanismes
Antriebe
Mechanisms
Mecanismos
Meccanismi
Mecanismos
Механизмы

LXQ 4

		🗑️					🗑️					ch - PS hp	kW	
⬆️	15 LVF 10 Optima	m/min	3,6	18	37	49	66						15	11
		kg	1600	1600	1600	1100	500							
⬆️	3 DVF5	m/min	19 - 41										3	2,2
		τ/min U/min rpm	0 0,8										2	1,5
⬆️	10 LVF 12 Optima	m/min	2	10	17	34	40						10	7,5
		kg	2400	2400	2400	1000	500							
⬆️	2 DVF5	m/min	15 - 38 (0 → 1000 kg)					15 - 30 (1000 → 2400 kg)					2	1,5
⬆️	RVF2-30	τ/min U/min rpm	0 → 0,8										2	1,5
		CEI 38	🔌		IEC 38		kVA							
		400 V (+6% -10%) 50 Hz					15 LVF 10 : 20 kVA 10 LVF 12 : 14 kVA							

15 LVF 10
Optima

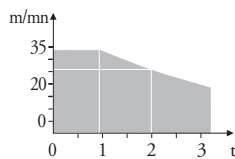

10 LVF 12
Optima

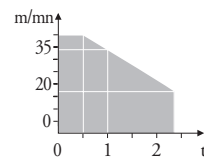

Montage
Montage
Erection
Montaje
Montaggio
Montagem
Монтаж

LXQ 3

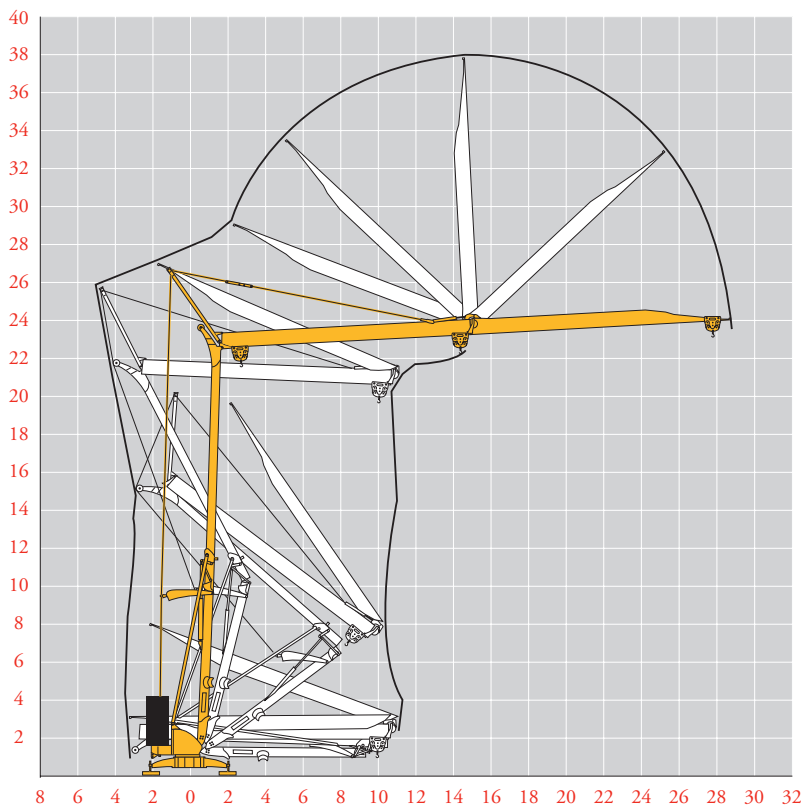

FR

Levage
Distribution
Orientation

DE

Heben
Katzfahren
Schwenken

EN

Hoisting
Trolleying
Slewing

ES

Elevación
Distribución
Orientación

IT

Sollevamento
Distribuzione
Rotazione

PT

Elevação
Distribuição
Rotação

RU

Подъем
Перемещение каретки
Поворот

Transport
 Transport
 Transport
 Transporte
 Trasporto
 Transporte
 Транспортировка

LXQ 4

DS61/S120		L (m)	B (m)	C (m)	D (m)	H (m)
DS61/S125	DS61/S120	15,9	2,45	4	6,81	3,05/3,2
DJ80/S120	DJ80/S120	15,9	2,45	4	6,81	3,1
DJ80/S125	DJ80/S125	15,9	2,45	4	6,81	3,1
DJ100/S120	DJ100/S120	16,33	2,45	4	6,81	3,1/3,23
DJ105/S125	DJ105/S125	16,33	2,45	4	6,81	3,1/3,23
DJ126M/S125	DJ126M/S125	16,35	2,45	4	6,81	3,2
DJ126M/S215M	DJ126M/S215M	17,14	3,24	4,07	6,74	3,55

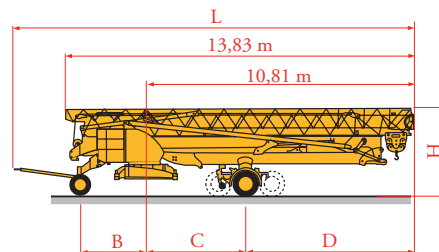

SL122/J215M		C (m)	D (m)
SL121/J135	SL122/J215M	4,07	6,74
SL121/S215M	SL121/J135	4	6,81
	SL121/S215M	4,07	6,74

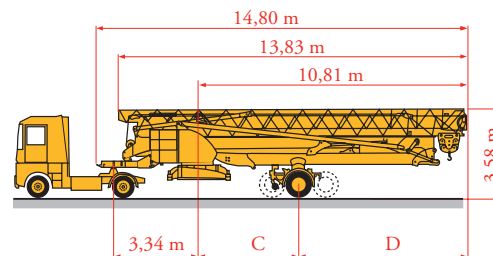

FR

○ Chantier

DE

Baustelle

EN

Site

ES

Obra

IT

Cantiere

PT

Estaleiro

RU

По строительной площадке



Document commercial non contractuel. Pour toute information technique se référer à la notice correspondante.

Unverbindliches Vertriebsdokument. Für technische Informationen, siehe die entsprechenden Anweisungen.

This commercial document is not legally binding. For any technical information, please refer to the corresponding instructions.

Documento commercial no contractual. Para cualquier información técnica, ver la noticia correspondiente.

Documento commerciale non vincolante, per tutte le informazioni tecniche fare riferimento al catalogo istruzioni.

Documento comercial não contratual. Para qualquer informação técnica complementar consultar as respectivas instruções.

Этот коммерческий документ не является юридически обязательным. Для получения технической информации, см. соответствующие инструкции.



Manitowoc - Americas - World Headquarters
 2400 S. 44th Street • Manitowoc • WI 54220 USA
 Tel: +1 920 684 4410 • Fax: +1 920 652 9778

Manitowoc - Europe, Middle East & Africa
 Manitowoc France SAS
 18, rue de Charbonnières B.P. 173 • 69132 ECULLY Cedex • FRANCE
 Tel: +33 (0)4 72 18 20 20 • Fax: +33 (0)4 72 18 20 00

Manitowoc - Asia Pacific
 16F Xu Hui Yuan Building,
 1089 Zhongshan No.2 Road (S) • Shanghai 200030 China
 Tel: +86 21 6457 0066 • Fax: +86 21 6457 4955

Igo 28A

REF. 2003 48 LXQ 6