

# Potain Igo 32

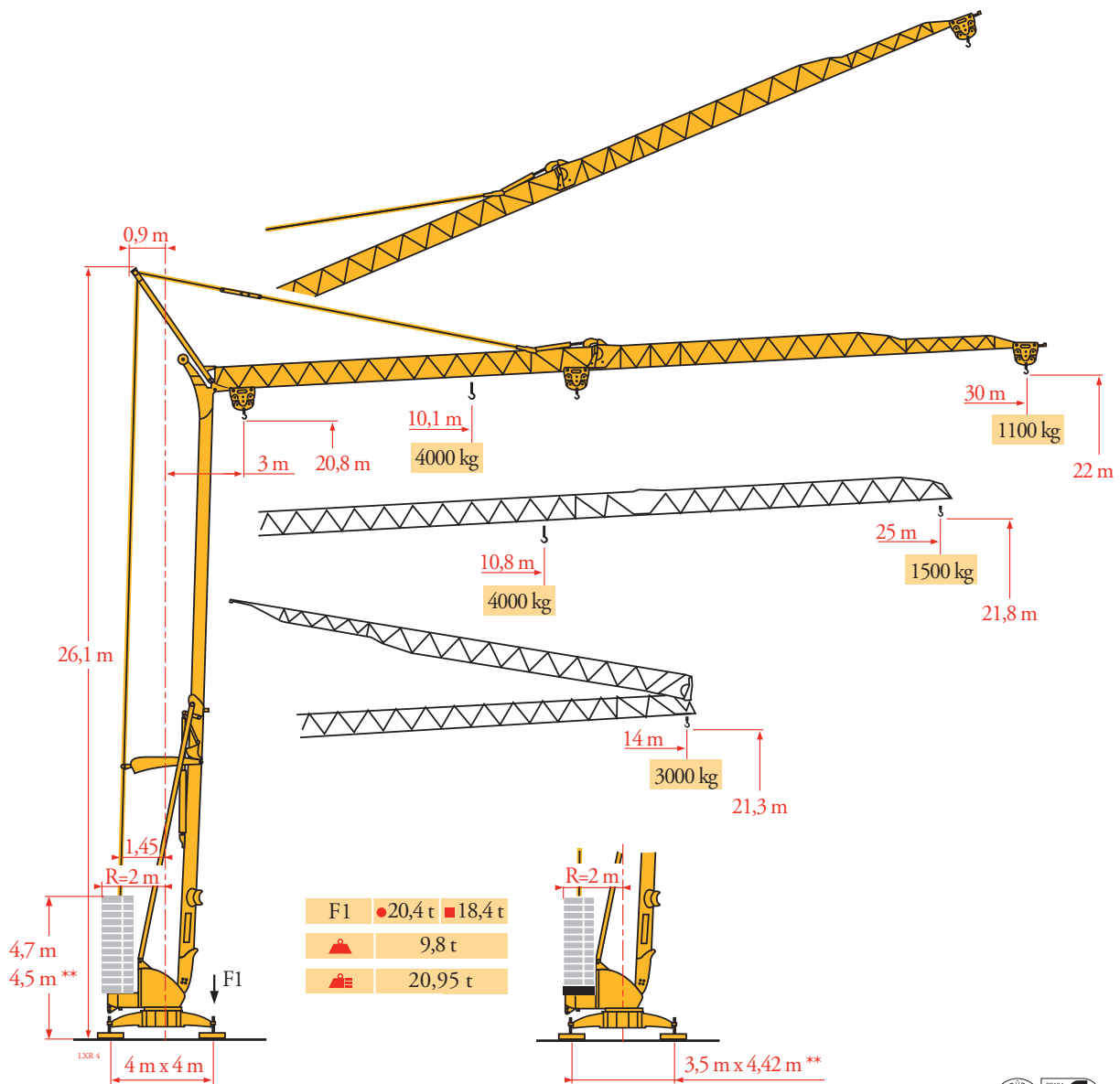

Courbes de charges  
Lastkurven  
Load diagrams  
Curvas de cargas  
Curve di carico  
Curva de cargas  
Диаграммы грузоподъемностей

LXR 3

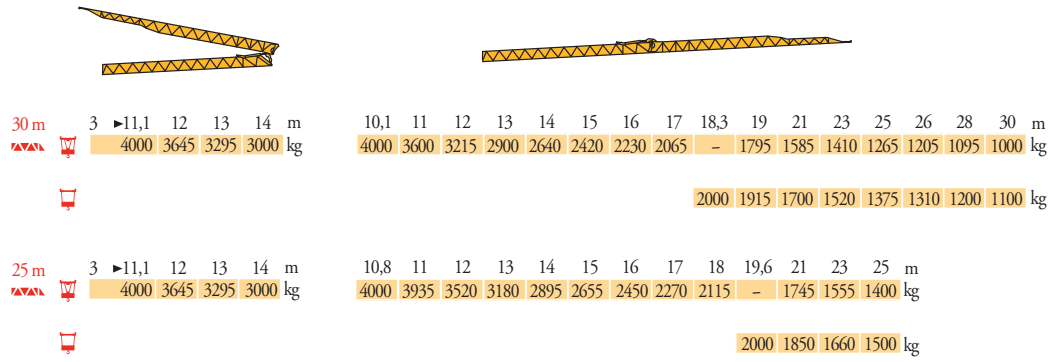

Flèche relevée  
Ausleger in Steilstellung  
Luffing jib  
Flecha izada  
Braccio impennato  
Lança inclinada  
Маховая стрела

LXR 4

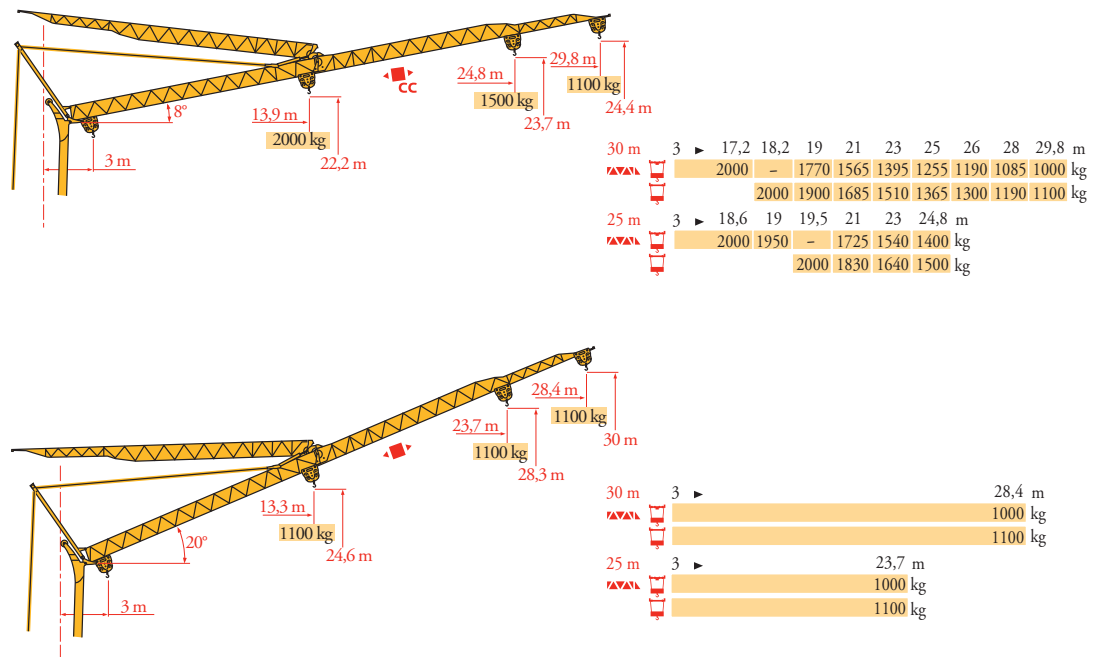

**FR**  
Chariot distributeur  
Chariot distributeur et courbes de charges  
Réactions en service  
Réactions hors service



Avide sans lest (ni train de transport) avec flèche et hauteur maximum



Poids total du lest

**DE**

Verfahrbare Laufkatze  
Verfahrbare Laufkatze und Lastkurven  
Reaktionskräfte in Betrieb  
Reaktionskräfte außer Betrieb

Ohne Last, Ballast (und Transportachse), mit Maximalausleger und Maximalhöhe

Ballast-Gesamtgewicht.

**EN**

Traversing trolley  
Traversing trolley and load diagrams  
Reactions in service  
Reactions out of service

Without load, ballast (or transport axes), with maximum jib and maximum height

Gross ballast weight.

**ES**

Carro distribuidor  
Carro distribuidor y curvas de cargas  
Reacciones en servicio  
Reacciones fuera de servicio

Sin carga, sin lastre, (ni tren de transporte), flecha y altura máxima

Peso total del lastre.

**IT**

Carrellino distributore  
Carrellino distributore e curve di carico  
Reazioni in servizio  
Reazioni fuori servizio

A vuoto, senza zavorra (ne assai di trasporto) con braccio massimo e altezza massima

Peso totale della zavorra.

**PT**

Carro distribuidor  
Carro distribuidor e curva de cargas  
Reações em serviço  
Reações fora de serviço

Sem carga (nem trem de transporte) - sem lastro com lança e altura máximas

Peso total do lastro.

**RU**

Грузовая тележка  
Грузовая тележка и диаграммы грузоподъемностей  
Реакции при работе  
Реакции в покое

Вес без груза, балласта (или транспортных осей), с максимальной длиной стрелы и максимальной высотой

общий вес груза

Mécanismes  
Antriebe  
Mechanisms  
Mecanismos  
Meccanismi  
Μεσανισμος  
Механизмы

LXR 3

		🗑️					🗑️					ch - PS hp	kW	
📍	<b>15 LVF 10 Optima</b>	m/min	3,6	18	30	49	66						15	11
		kg	2000	2000	2000	1100	500							
		m/min	3,6	18	30	54	66	1,8	8,9	15	27	33		
		kg	2000	2000	2000	1000	500	4000	4000	4000	2000	1000		
📍	<b>3 DVF5</b>	m/min	19 - 41									3	2,2	
📍	<b>RVF+31</b>	α/min U/min rpm	0 → 0,8									2	1,5	
CEI 38 📍 IEC 38						📍 kVA								
400 V (+6% -10%) 50 Hz						15 LVF 10 : 20 kVA								

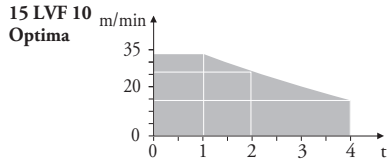

Montage  
Montage  
Erection  
Montaje  
Montaggio  
Montagem  
Монтаж

LXR 3

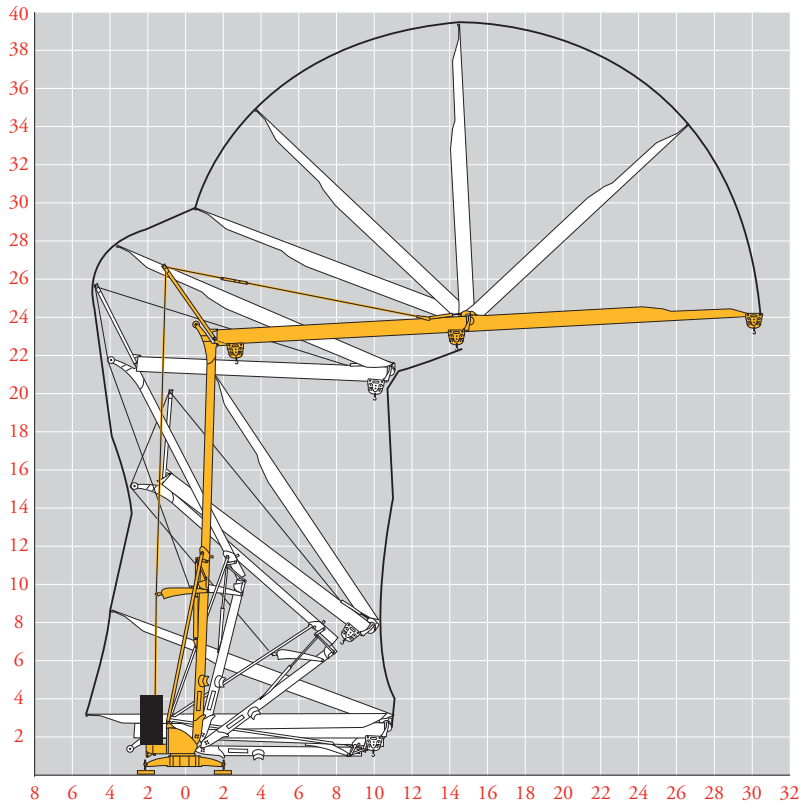

**FR**  
Levage  
Distribution  
Orientation

**DE**  
Heben  
Katzfahren  
Schwenken

**EN**  
Hoisting  
Trolleying  
Slewing

**ES**  
Elevación  
Distribución  
Orientación

**IT**  
Sollevamento  
Distribuzione  
Rotazione

**PT**  
Elevação  
Distribuição  
Rotação

**RU**  
Подъем  
Перемещение каретки  
Поворот

Transport  
Transport  
Transport  
Transporte  
Trasporto  
Transporte  
Транспортировка

LXR 5

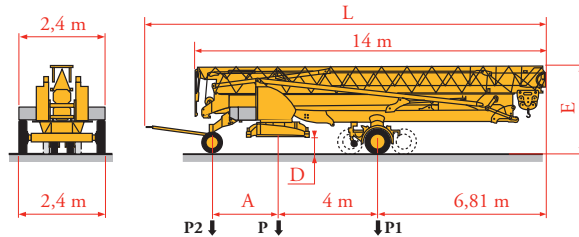

	Km/h	A (m)	D (m)	E (m)	L (m)	P (kg)	P1 (kg)	P2 (kg)
DS62/S120	10	2,35	0,36/0,21	3,2/3,05	15,48	15405	9480	5925
DS61/S125	25	2,45	0,36/0,21	3,2/3,05	15,77	15755	9782	5973

... \*\*

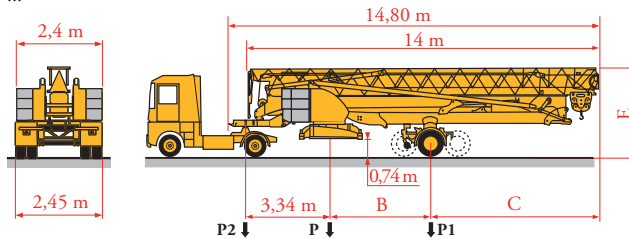

	Km/h	B (m)	C (m)	E (m)	P (kg)	P1 (kg)	P2 (kg)
SL121/J135	25	4,00	6,81	3,85	23070/16670	13200/11460	9870/5210
SL122/J215M	80	4,07	6,74	3,58	24140/17740	14170/12430	9970/5310

... \*\*



\*\*

**FR**

Transport grue toute lestée.

Voir documentations techniques.

**DE**

Krantransport mit voller Ballastierung.

Siehe technische Dokumentation.

**EN**

Transport of crane with full ballast.

See technical documentations.

**ES**

Transporte grúa completamente lastrada.

Consulte la documentación técnica.

**IT**

Trasporto con gru completamente zavorrata. Vedere la documentazione tecnica.

**PT**

Transporte de grua totalmente balastada. Consultar documentação técnica.

**RU**

Перевозка крана с полным балластом см. техническую документацию



Document commercial non contractuel. Pour toute information technique se référer à la notice correspondante.

Unverbindliches Vertriebsdokument. Für technische Informationen, siehe die entsprechenden Anweisungen.

This commercial document is not legally binding. For any technical information, please refer to the corresponding instructions.

Documento comercial no contractual. Para cualquier información técnica, ver la noticia correspondiente.

Documento commerciale non vincolante, per tutte le informazioni tecniche fare riferimento al catalogo istruzioni.

Documento comercial não contratual. Para qualquer informação técnica complementar consultar as respectivas instruções.

Этот коммерческий документ не является юридически обязательным. Для получения технической информации, см. соответствующие инструкции.

**SW-Mietservice**  
Baumaschinen und Baugeräte

SW-Mietservice GmbH&Co.KG

Herzogstraße 8

49762 Renkenberge

Tel.: 05933-6466880

Fax: 05933-6466881

E-Mail: [Info@sw-mietservice.de](mailto:Info@sw-mietservice.de)

**Manitowoc**

**Manitowoc - Americas - World Headquarters**

2400 S. 44th Street • Manitowoc • WI 54220 USA  
Tel: +1 920 684 4410 • Fax: +1 920 652 9778

**Manitowoc - Europe, Middle East & Africa**

Ecully, France  
18, rue de Charbonnières B.P. 173 • 69132 ECULLY Cedex • FRANCE  
Tel: +33 (0)4 72 18 20 20 • Fax: +33 (0)4 72 18 20 00

**Manitowoc - Asia Pacific**

16F Xu Hui Yuan Building,  
1089 Zhongshan No.2 Road (S) • Shanghai 200030 China  
Tel: +86 21 6457 0066 • Fax: +86 21 6457 4955